















|  | Ref.              |  |  |  |  |  |
|---|-------------------|---|---|---|---|---|
| DRIVER (TVH.MC.08003)   | LECTRD0060CFNT006 | 198-264 V   | 50/60 Hz  | 0.16-0.21   | Tw 80°C   | Tc 95-100°C   |
| DRIVER (TVH.MC.11503)   | LECTRD0090CFNT000 | 198-264 V   | 50/60 Hz  | 0.25-0.33   | Tw 80°C   | Tc 95-100°C   |
| DRIVER (TVH.MC.13003)   | LECTRD0090CFNT000 | 198-264 V   | 50/60 Hz  | 0.28-0.37   | Tw 80°C   | Tc 95-100°C   |
| DRIVER (TVH.MC.14003)   | LECTRD0090CFNT000 | 198-264 V   | 50/60 Hz  | 0.32-0.42   | Tw 80°C   | Tc 95-100°C   |
| DRIVER (TVH.MC.15003)   | LECTRD0135CFNT000 | 198-264 V   | 50/60 Hz  | 0.33-0.44   | Tw 80°C   | Tc 95-100°C   |
| DRIVER (TVH.MC.17503)   | LECTRD0135CFNT000 | 198-264 V   | 50/60 Hz  | 0.40-0.53   | Tw 80°C   | Tc 95-100°C   |
| DRIVER (TVH.MC.21003)   | LECTRD0200CFNT000 | 198-264 V   | 50/60 Hz  | 0.50-0.66   | Tw 80°C   | Tc 95-100°C   |

# TARTESSOS MINI ESSENCE HP

- INSTRUCCIONES DE MONTAJE
- MOUNTING INSTRUCTIONS
- MONTAGEANLEITUNG
- INSTRUCTIONS DE MONTAGE



| Serie  |  |  |  |  |  |  |
|--|---|---|---|---|---|---|
| TARTESSOS ESSENCE HP TVH.MI.08003.D.X1.X2.X3 | A381 B275 H113  | 38,3W   | 42W   | 6,5 Kg  | 0.16-0.21   | Tc 95-100°C   |
| TARTESSOS ESSENCE HP TVH.MI.11503.D.X1.X2.X3 | A381 B275 H113  | 59,6W   | 65W   | 6,5 Kg  | 0.25-0.33   | Tc 95-100°C   |
| TARTESSOS ESSENCE HP TVH.MI.13003.D.X1.X2.X3 | A381 B275 H113  | 67,5W   | 73W   | 6,5 Kg  | 0.28-0.37   | Tc 95-100°C   |
| TARTESSOS ESSENCE HP TVH.MI.14003.D.X1.X2.X3 | A381 B275 H113  | 77W   | 84W   | 6,5 Kg  | 0.32-0.42   | Tc 95-100°C   |
| TARTESSOS ESSENCE HP TVH.MI.15003.D.X1.X2.X3 | A381 B275 H113  | 80,4W   | 87W   | 6,5 Kg  | 0.33-0.44   | Tc 95-100°C   |
| TARTESSOS ESSENCE HP TVH.MI.17503.D.X1.X2.X3 | A381 B275 H113  | 98W   | 105W  | 6,5 Kg  | 0.40-0.53   | Tc 95-100°C   |
| TARTESSOS ESSENCE HP TVH.MI.21003.D.X1.X2.X3 | A381 B275 H113  | 123,5W  | 131W  | 6,5 Kg  | 0.50-0.66   | Tc 95-100°C   |

    
 MODLEDLFTXXX 80V CC Tc2 87-92°C (PCB medido junto al D23)  
 Potencia/Power 25/35/45/58/78W  
 Corriente/Intensity 300/440/560/725/970 mA



Polígono Industrial El Olivar, C/ Copejadores N2 11160 Barbate (Cádiz) España  
 Tel.: +34 956 454 130 ·

info@lecsl.com | www.lecsl.com



“Empresa certificada en diseño y fabricación de luminarias LED”

Ta:50°C Temp. Max .ambiente de funcionamiento.  
 External Temp. max. of working.

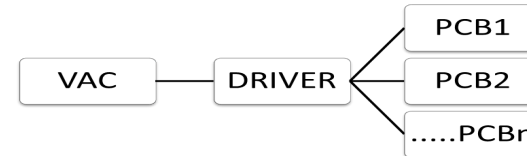

**ES** Esta luminaria está destinada exclusivamente a iluminación y debe ser instalada de acuerdo con las pertinentes normas nacionales. Cualquier otro uso o instalación no se considerará “acorde a las instrucciones de montaje”.

**FR** Le luminaire sert uniquement à l'éclairage et doit être installé conformément aux prescriptions nationales en matière d'installation. Toute autre utilisation ou installation est considérée comme “non conforme”

**EN** The luminaire is used exclusively for lighting and to be installed in accordance with the national installation regulations. Any other use or installation is regarded as “not according to instructions”.

**DE** Die Leuchte dient ausschließlich der Beleuchtung und ist entsprechend den nationalen Errichtungsbestimmungen zu installieren. Eine andere Nutzung oder ein anderer Einbau gilt als „nicht bestimmungsgemäß“.



**ES** El montaje y la puesta en marcha sólo puede ser realizado por personal especialmente autorizado. La fuente de luz de esta luminaria debe reemplazarse únicamente por el fabricante, su servicio técnico o persona cualificada equivalente.

**FR** L'installation et la mise en service doivent obligatoirement être effectuées par des techniciens. La source lumineuse de ce luminaire ne doit être remplacée que par le fabricant, son service technique ou une personne qualifiée équivalente.

**EN** Installation and commissioning shall only be carried out by authorized specialist. The light source of this luminaire should be replaced only by the manufacturer, its technical service or equivalent qualified person.

**DE** Die Montage und Inbetriebnahme darf nur von autorisiertem Fachpersonal durchgeführt werden. Die Lichtquelle dieser Leuchte darf nur vom Hersteller, seinem technischen Kundendienst oder einer gleichwertigen qualifizierten Person ausgetauscht werden.

**ES** Cable de alimentación tipo Y. Si el cable flexible o cordón de esta luminaria está dañado, debe sustituirse por un cable flexible o cordón especial que suministre exclusivamente el fabricante o su servicio técnico. El cableado que se monte en el interior de la luminaria debe poseer doble aislamiento o aislamiento reforzado.

**FR** Le câble d'alimentation type Y. Si le câble flexible ou le cordon de ce luminaire est endommagé, vous devez le remplacer par un câble flexible ou un cordon spécial qui est fourni uniquement par le fabricant ou par son département technique. Le câblage monté à l'intérieur du luminaire doit être à double isolation ou à isolation renforcée.

**EN** Power cord type-Y. If the flexible cable or cord of this luminaire is damaged, it must be replaced with a flexible cable or a special cord exclusively supplied by the manufacturer or its technical support. The wiring that is mounted inside the luminaire must have double insulation or reinforced insulation.

**DE** Anschlussleitung Typ Y. Wenn die flexiblen Leitung dieser Leuchte beschädigt ist, muss es mit einem flexiblen Kabel oder einem Spezialkabel ausschließlich vom Hersteller oder dessen technischen Support versorgt ersetzt werden. Die Verkabelung, die in der Leuchte montiert wird, muss doppelt oder verstärkt

Non replaceable light source

Replaceable control gear by a professional



2/2

1

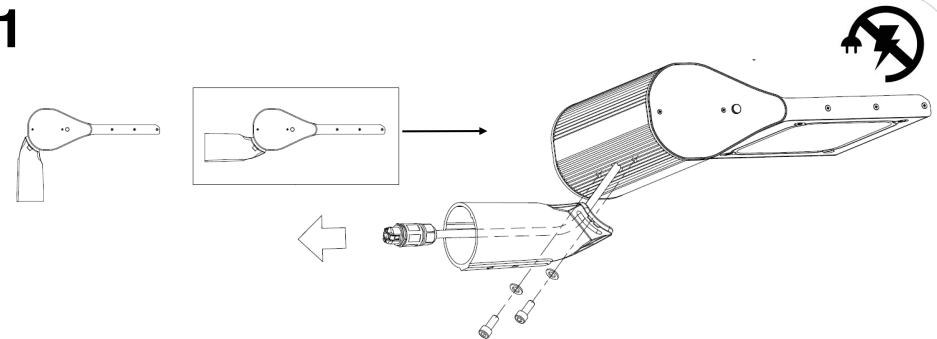

2

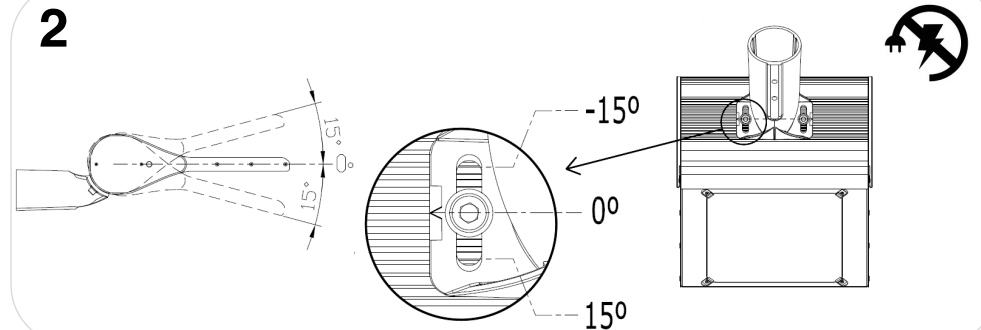

3

